

Declaration of Performance

1343-CPR-M 530-7/01.15

1. Unique identification code of the product-type: Bonded injection type anchor Mungo MIT-SP/MIT-SPE Plus, MIT-SP Winter for use in non-cracked concrete

2. Manufacturer: Mungo Befestigungstechnik AG, Bornfeldstrasse 2, CH-4603 Olten/Switzerland

3. System/s of AVCP: System 1

4. Intended use or use/es:

Product	Intended use
Metal anchors for use in concrete	For fixing and/or supporting to concrete, structural elements (which contributes to the stability of the works) or heavy units.

5. European Assessment Document: ETAG 001-Part 1 and Part 5, edition 2013, used as EAD

European Technical Assessment: ETA-13/0032 of 04/01/2017

Technical Assessment Body: ZUS – Technical and Test Institute for Construction Prague

Notified body/ies: 1343 – MPA Darmstadt

6. Declared performance:

Mechanical resistance and stability (BWR 1)

Essential characteristic	Performance
Characteristic resistance for tension loads	See appendix, especially Annex C1
Characteristic resistance for shear loads	See appendix, especially Annex C2
Displacement	See appendix, especially Annex C3

Safety in case of fire (BWR 2)

Essential characteristic	Performance
Reaction to fire	Anchorage satisfy requirements for Class A1
Resistance to fire	No performance assessed

The performance of the product identified above is in conformity with the set of declared performance/s. This declaration of performance is issued, in accordance with Regulation (EU) No 305/2011, under the sole responsibility of the manufacturer identified above.

Signed for and on behalf of the manufacturer by:

Dipl.-Ing. Massimo Pirozzi
Head of Engineering



Olten, 2017-21-12



This DoP Has been prepared in different languages. In case there is a dispute on the interpretation the English version shall always prevail.

The Appendix includes voluntary and complementary information in English language exceeding the (language as neutrally specified) legal requirements.

Installation threaded rod

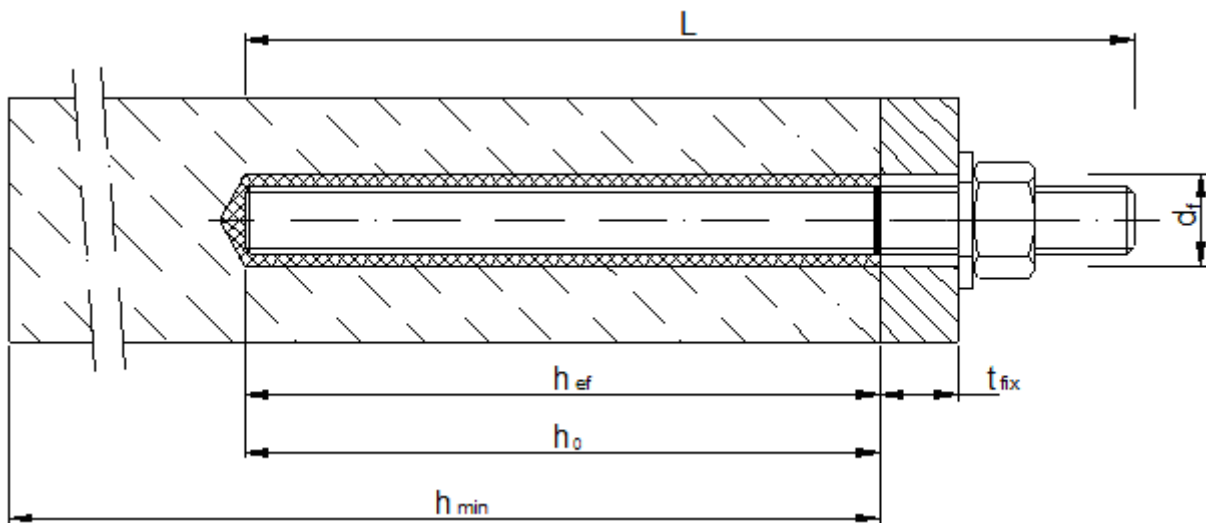

- d_f = diameter of clearance hole in the fixture
 t_{fix} = thickness of fixture
 h_{ef} = effective embedment depth
 h_0 = depth of drill hole
 h_{min} = minimum thickness of member

**MUNGO Injection System for concrete
MIT-SP / MIT-SPE Plus, MIT-SP Winter**

Product description
Installed conditions

Annex A 1

Cartridge: MIT-SP / MIT-SPE Plus, MIT-SP Winter

150 ml, 280 ml, 300 ml up to 330 ml and 380 ml up to 420 ml cartridge (Type: coaxial)

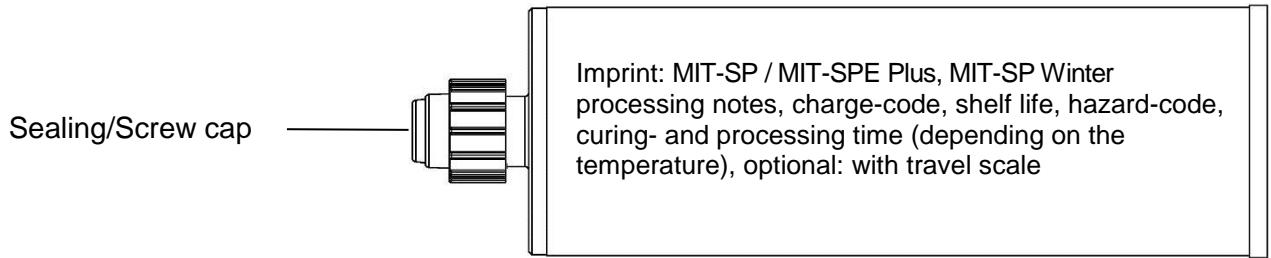

235 ml, 345 ml up to 360 ml and 825 ml cartridge (Type: "side-by-side")

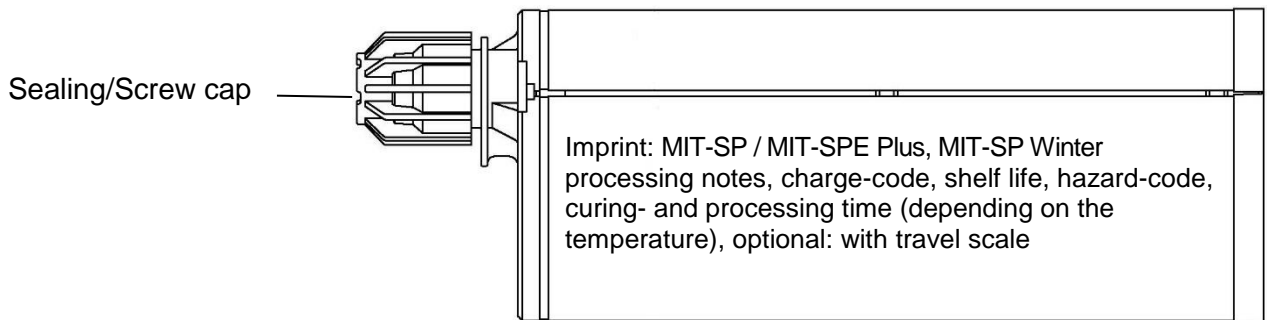

165 ml and 300 ml cartridge (Type: "foil tube")

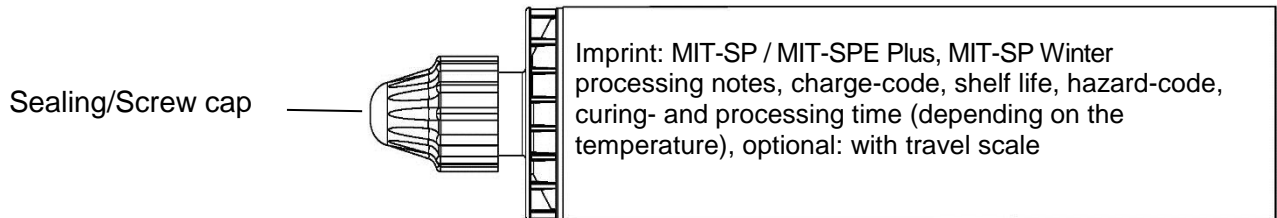

Static mixer

SM 14W



CM 8W



MUNGO Injection System for concrete
MIT-SP / MIT-SPE Plus, MIT-SP Winter

Product description
 Injection system

Annex A 2

Threaded rod M8, M10, M12, M16, M20, M24 with washer and hexagon nut

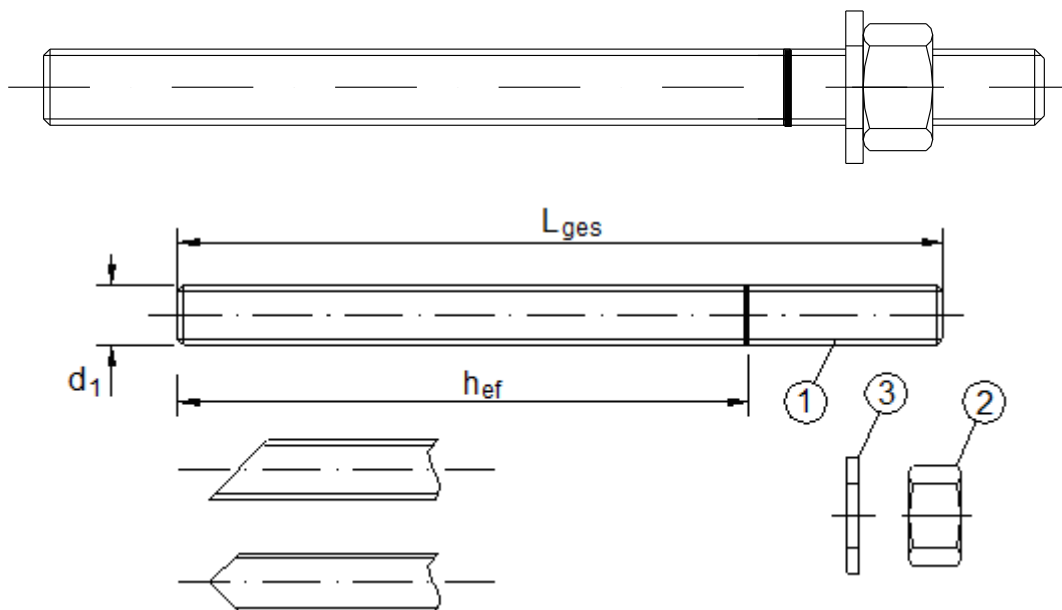

Commercial standard threaded rod with:

- Materials, dimensions and mechanical properties acc. Table A1
- Inspection certificate 3.1 acc. to EN 10204:2004
- Marking of embedment depth

**MUNGO Injection System for concrete
MIT-SP / MIT-SPE Plus, MIT-SP Winter**

Product description
Threaded rod

Annex A 3

Table A1: Materials		
Part	Designation	Material
Steel, zinc plated $\geq 5 \mu\text{m}$ acc. to EN ISO 4042:1999 or Steel, hot-dip galvanised $\geq 40 \mu\text{m}$ acc. to EN ISO 1461:2009 and EN ISO 10684:2004+AC:2009		
1	Anchor rod	Steel, EN 10087:1998 or EN 10263:2001 Property class 4.6, 4.8, 5.8, 8.8, EN 1993-1-8:2005+AC:2009
2	Hexagon nut, EN ISO 4032:2012	Steel acc. to EN 10087:1998 or EN 10263:2001 Property class 4 (for class 4.6 or 4.8 rod) EN ISO 898-2:2012, Property class 5 (for class 5.8 rod) EN ISO 898-2:2012, Property class 8 (for class 8.8 rod) EN ISO 898-2:2012
3	Washer, EN ISO 887:2006, EN ISO 7089:2000, EN ISO 7093:2000 or EN ISO 7094:2000	Steel, zinc plated or hot-dip galvanised
Stainless steel		
1	Anchor rod	Material 1.4401 / 1.4404 / 1.4571, EN 10088-1:2005, Property class 70 EN ISO 3506-1:2009
2	Hexagon nut, EN ISO 4032:2012	Material 1.4401 / 1.4404 / 1.4571 EN 10088-1:2005, Property class 70 (for class 70 rod) EN ISO 3506-2:2009
3	Washer, EN ISO 887:2006, EN ISO 7089:2000, EN ISO 7093:2000 or EN ISO 7094:2000	Material 1.4401, 1.4404 or 1.4571, EN 10088-1:2005
High corrosion resistant steel		
1	Anchor rod	Material 1.4529 / 1.4565, EN 10088-1:2005, Property class 70 EN ISO 3506-1:2009
2	Hexagon nut, EN ISO 4032:2012	Material 1.4529 / 1.4565 EN 10088-1:2005, Property class 70 (for class 70 rod) EN ISO 3506-2:2009
3	Washer, EN ISO 887:2006, EN ISO 7089:2000, EN ISO 7093:2000 or EN ISO 7094:2000	Material 1.4529 / 1.4565, EN 10088-1:2005
MUNGO Injection System for concrete MIT-SP / MIT-SPE Plus, MIT-SP Winter		Annex A 4
Product description Materials		

Specifications of intended use

Anchorage subject to:

- Static and quasi-static loads

Base materials:

- Reinforced or unreinforced normal weight concrete according to EN 206-1:2000.
- Strength classes C20/25 to C50/60 according to EN 206-1:2000.
- Non-cracked concrete

Temperature range:

- I: - 40 °C to +40 °C (max long term temperature +24 °C and max short term temperature +40 °C)
- II: - 40 °C to +80 °C (max long term temperature +50 °C and max short term temperature +80 °C)

Use conditions (Environmental conditions):

- Structures subject to dry internal conditions (zinc coated steel, stainless steel or high corrosion resistant steel).
- Structures subject to external atmospheric exposure (including industrial and marine environment) and to permanently damp internal condition, if no particular aggressive conditions exist (stainless steel or high corrosion resistant steel).
- Structures subject to external atmospheric exposure and to permanently damp internal condition, if other particular aggressive conditions exist (high corrosion resistant steel).

Note: Particular aggressive conditions are e.g. permanent, alternating immersion in seawater or the splash zone of seawater, chloride atmosphere of indoor swimming pools or atmosphere with extreme chemical pollution (e.g. in desulphurization plants or road tunnels where de-icing materials are used).

Design:

- Verifiable calculation notes and drawings are prepared taking account of the loads to be anchored. The position of the anchor is indicated on the design drawings (e. g. position of the anchor relative to reinforcement or to supports, etc.).
- Anchorages are designed under the responsibility of an engineer experienced in anchorages and concrete work.
- Anchorages under static or quasi-static actions are designed in accordance with:
 - EOTA Technical Report TR 029 "Design of bonded anchors", Edition September 2010 or
 - CEN/TS 1992-4:2009

Installation:

- Dry, wet or flooded bore holes.
- Hole drilling by hammer or compressed air drill mode.
- Overhead installation allowed.
- Anchor installation carried out by appropriately qualified personnel and under the supervision of the person responsible for technical matters of the site

**MUNGO Injection System for concrete
MIT-SP / MIT-SPE Plus, MIT-SP Winter**

**Intended use
Specifications**

Annex B 1

Table B1: Installation parameters for threaded rod

Anchor size		M 8	M 10	M 12	M 16	M 20	M 24
Nominal drill hole diameter	d_0 [mm] =	10	12	14	18	24	28
Effective anchorage depth	$h_{ef,min}$ [mm] =	60	60	70	80	90	96
	$h_{ef,max}$ [mm] =	160	200	240	320	400	480
Diameter of clearance hole in the fixture	d_f [mm] ≤	9	12	14	18	22	26
Diameter of steel brush	d_b [mm] ≥	12	14	16	20	26	30
Torque moment	T_{inst} [Nm] ≤	10	20	40	80	120	160
Thickness of fixture	$t_{fix,min}$ [mm] >	0					
	$t_{fix,max}$ [mm] <	1500					
Minimum thickness of member	h_{min} [mm]	$h_{ef} + 30 \text{ mm}$ ≥ 100 mm			$h_{ef} + 2d_0$		
Minimum spacing	s_{min} [mm]	40	50	60	80	100	120
Minimum edge distance	c_{min} [mm]	40	50	60	80	100	120

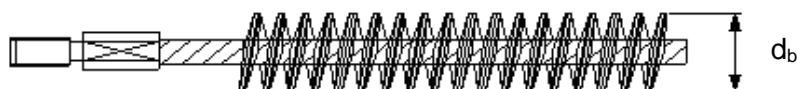
Steel brush**Table B2: Parameter cleaning and setting tools**

Threaded Rod	d_0 Drill bit - Ø	d_b Brush - Ø	$d_{b,min}$ min. Brush - Ø
(mm)	(mm)	(mm)	(mm)
M8	10	12	10,5
M10	12	14	12,5
M12	14	16	14,5
M16	18	20	18,5
M20	24	26	24,5
M24	28	30	28,5

**Hand pump (volume 750 ml)**

Drill bit diameter (d_0): 10 mm to 20 mm
and anchorage depth up to 240 mm



**Recommended compressed air tool (min 6 bar)**

All applications

MUNGO Injection System for concrete
MIT-SP / MIT-SPE Plus, MIT-SP Winter

Intended use
Installation parameters
Cleaning and setting tools

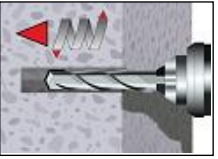
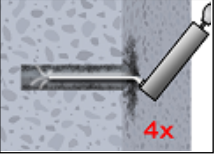
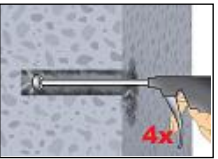
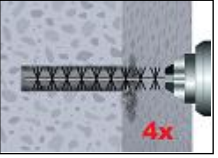
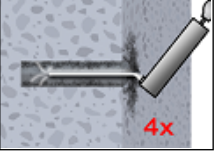
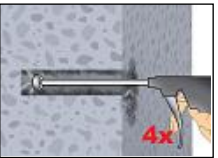
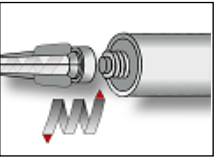
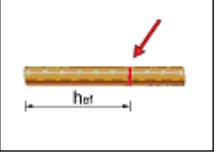
Annex B 2

<h3>Installation instructions</h3>	
	<p>1 Drill with hammer drill a hole into the base material to the size and embedment depth required by the selected anchor (Table B1). In case of aborted drill hole: the drill hole shall be filled with mortar.</p>
<p>or</p>  <p>4x</p> <p>or</p>  <p>4x</p>  <p>4x</p>  <p>4x</p> <p>or</p>  <p>4x</p>	<p>Attention! Standing water in the bore hole must be removed before cleaning.</p> <p>2a Starting from the bottom or back of the bore hole, blow the hole clean with compressed air (min. 6 bar) or a hand pump (Annex B2) a minimum of four times. If the bore hole ground is not reached an extension shall be used.</p> <p>The hand-pump can be used for anchor sizes up to bore hole diameter 20 mm.</p> <p>For bore holes larger then 20 mm or deeper 240 mm, compressed air (min. 6 bar) must be used.</p> <p>2b Check brush diameter (Table B2) and attach the brush to a drilling machine or a battery screwdriver. Brush the hole with an appropriate sized wire brush $> d_{b,min}$ (Table B2) a minimum of four times. If the bore hole ground is not reached with the brush, a brush extension shall be used (Table B2).</p> <p>2c Finally blow the hole clean again with compressed air (min. 6 bar) or a hand pump (Annex B2) a minimum of four times. If the bore hole ground is not reached an extension shall be used. The hand-pump can be used for anchor sizes up to bore hole diameter 20 mm. For bore holes larger than 20 mm or deeper 240 mm, compressed air (min. 6 bar) must be used.</p> <p>After cleaning, the bore hole has to be protected against re-contamination in an appropriate way, until dispensing the mortar in the bore hole. If necessary, the cleaning repeated has to be directly before dispensing the mortar. In-flowing water must not contaminate the bore hole again</p>
   <p>min. 3 full stroke</p>	<p>3. Attach a supplied static-mixing nozzle to the cartridge and load the cartridge into the correct dispensing tool. Cut off the foil tube clip before use. For every working interruption longer than the recommended working time (Table B3) as well as for new cartridges, a new static-mixer shall be used.</p> <p>4. Prior to inserting the anchor rod into the filled bore hole, the position of the embedment depth shall be marked on the anchor rods.</p> <p>5. Prior to dispensing into the drill hole, squeeze out separately a minimum of three full strokes and discard non-uniformly mixed adhesive components until the mortar shows a consistent grey colour. For foil tube cartridges it must be discarded a minimum of six full strokes.</p>
<p>MUNGO Injection System for concrete MIT-SP / MIT-SPE Plus, MIT-SP Winter</p>	
<p>Intended use Installation instructions</p>	<p>Annex B 3</p>

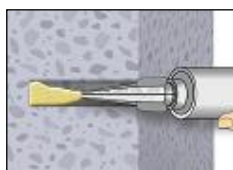
Installation instructions (continuation)

6. Starting from the bottom or back of the cleaned anchor hole fill the hole up to approximately two-thirds with adhesive. Slowly withdraw the static mixing nozzle as the hole fills to avoid creating air pockets. For embedment larger than 190 mm an extension nozzle shall be used. Observe the gel-/ working times given in Table B3.

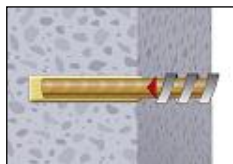

7. Push the threaded rod into the anchor hole while turning slightly to ensure positive distribution of the adhesive until the embedment depth is reached.

The anchor should be free of dirt, grease, oil or other foreign material.

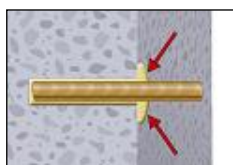

8. Be sure that the anchor is fully seated at the bottom of the hole and that excess mortar is visible at the top of the hole. If these requirements are not maintained, the application has to be renewed. For overhead application the anchor rod should be fixed (e.g. wedges).

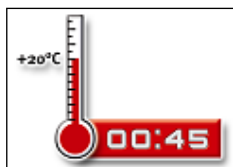

9. Allow the adhesive to cure to the specified time prior to applying any load or torque. Do not move or load the anchor until it is fully cured (attend Table B3).



10. After full curing, the add-on part can be installed with the max. torque (Table B1) by using a calibrated torque wrench.

Table B3: Minimum curing time

Concrete temperature [°C]	MIT-SP / MIT-SPE Plus		MIT-SP Winter	
	working time [min]	minimum curing time [min]	working time [min]	minimum curing time [min]
-10 to -6			60	240
-5 to -1	90	360	45	120
0 to +4	45	180	25	80
+5 to +9	25	120	10	45
+10 to +14	20	100	4	25
+15 to +19	15	80	3	20
+20 to +29	6	45	2	15
+30 to +34	4	25		
+35 to +39	2	20		
Cartridge temperature	+5°C to +40°C		-5°C to +30°C	

**MUNGO Injection System for concrete
MIT-SP / MIT-SPE Plus, MIT-SP Winter**

Intended use
Installation instructions (continuation)
Curing time

Annex B 4

Table C1: Characteristic values under tension loads in non-cracked concrete									
Anchor size threaded rod				M 8	M 10	M 12	M 16	M 20	M24
Steel failure									
Characteristic tension resistance		$N_{Rk,s}$	[kN]	$A_s \times f_{uk}$					
Combined pull-out and concrete failure									
Characteristic bond resistance in non-cracked concrete C20/25									
Temperature range I: 40°C/24°C	dry and wet concrete	$\tau_{Rk,ucr}$	[N/mm ²]	8,5	8,0	8,0	8,0	8,0	8,0
	flooded bore hole	$\tau_{Rk,ucr}$	[N/mm ²]	8,5	8,0	8,0	8,0	8,0	8,0
Temperature range II: 80°C/50°C	dry and wet concrete	$\tau_{Rk,ucr}$	[N/mm ²]	6,5	6,0	6,0	6,0	6,0	6,0
	flooded bore hole	$\tau_{Rk,ucr}$	[N/mm ²]	6,5	6,0	6,0	6,0	6,0	6,0
Increasing factors for concrete ψ_c		C25/30		1,04					
		C30/37		1,08					
		C35/45		1,13					
		C40/50		1,15					
		C45/55		1,17					
		C50/60		1,19					
Factor according to CEN/TS 1992-4-5 Section 6.2.2.3		k_8	[-]	10,1					
Concrete cone failure									
Factor according to CEN/TS 1992-4-5 Section 6.2.3.1		k_{ucr}	[-]	10,1					
Edge distance		$c_{cr,N}$	[mm]	$1,5 h_{ef}$					
Axial distance		$s_{cr,N}$	[mm]	$3,0 h_{ef}$					
Splitting failure									
Edge distance		$c_{cr,sp}$	[mm]	$1,0 \cdot h_{ef} \leq 2 \cdot h_{ef} \left(2,5 - \frac{h}{h_{ef}} \right) \leq 2,4 \cdot h_{ef}$					
Axial distance		$s_{cr,sp}$	[mm]	$2 c_{cr,sp}$					
Installation safety factor (dry and wet concrete)		$\gamma_2 = \gamma_{inst}$	[-]	1,2					
Installation safety factor (flooded bore hole)		$\gamma_2 = \gamma_{inst}$	[-]	1,2					
MUNGO Injection System for concrete MIT-SP / MIT-SPE Plus, MIT-SP Winter							Annex C 1		
Performances Characteristic values under tension loads in non-cracked concrete									

Table C2: Characteristic values under shear loads in non-cracked concrete								
Anchor size threaded rod		M 8	M 10	M 12	M 16	M 20	M24	
Steel failure without lever arm								
Characteristic shear resistance,	$V_{Rk,s}$	[kN]	$0,5 \times A_s \times f_{uk}$					
Ductility factor according to CEN/TS 1992-4-5 Section 6.3.2.1	k_2	[-]	0,8					
Steel failure with lever arm								
Characteristic bending moment,	$M^0_{Rk,s}$	[Nm]	$1.2 \times W_{el} \times f_{uk}$					
Concrete pry-out failure								
Factor k_3 in equation (27) of CEN/TS 1992-4-5 Section 6.3.3 Factor k in equation (5.7) of Technical Report TR 029	$k_{(3)}$	[-]	2,0					
Installation safety factor	$\gamma_2 = \gamma_{inst}$	[-]	1,0					
Concrete edge failure								
Effective length of anchor	l_f	[mm]	$l_f = \min(h_{ef}; 8 d_{nom})$					
Outside diameter of anchor	d_{nom}	[mm]	8	10	12	16	20	24
Installation safety factor	$\gamma_2 = \gamma_{inst}$	[-]	1,0					
MUNGO Injection System for concrete MIT-SP / MIT-SPE Plus, MIT-SP Winter						Annex C 2		
Performances Characteristic values under shear loads in non-cracked concrete								

Table C3: Displacement under tension load¹⁾

Anchor size threaded rod		M 8	M 10	M 12	M 16	M 20	M 24	
Non-cracked concrete C20/25								
Temperature range I: 40°C/24°C	δ_{N0} -factor	[mm/(N/mm ²)]	0,03	0,04	0,05	0,07	0,08	0,10
	$\delta_{N\infty}$ -factor	[mm/(N/mm ²)]	0,07	0,08	0,08	0,08	0,08	0,10
Temperature range II: 80°C/50°C	δ_{N0} -factor	[mm/(N/mm ²)]	0,02	0,03	0,03	0,04	0,04	0,05
	$\delta_{N\infty}$ -factor	[mm/(N/mm ²)]	0,15	0,17	0,17	0,17	0,17	0,17

¹⁾ Calculation of the displacement

$$\delta_{N0} = \delta_{N0}\text{-factor} \cdot \tau;$$

$$\delta_{N\infty} = \delta_{N\infty}\text{-factor} \cdot \tau;$$

Table C4: Displacement under shear load¹⁾

Anchor size threaded rod		M 8	M 10	M 12	M 16	M 20	M 24	
For non-cracked concrete C20/25								
All temperature ranges	δ_{V0} -factor	[mm/(kN)]	0,02	0,02	0,01	0,01	0,01	0,01
	$\delta_{V\infty}$ -factor	[mm/(kN)]	0,03	0,02	0,02	0,01	0,01	0,01

¹⁾ Calculation of the displacement

$$\delta_{V0} = \delta_{V0}\text{-factor} \cdot V;$$

$$\delta_{V\infty} = \delta_{V\infty}\text{-factor} \cdot V;$$

**MUNGO Injection System for concrete
MIT-SP / MIT-SPE Plus, MIT-SP Winter**

Performances
Displacement

Annex C 3