

MIT-SP Mortar for use in masonry

Injection anchors for use in masonry.

The anchor is placed into a drilled hole filled with injection mortar. The steel element is anchored via the bond between metal part, injection mortar and masonry.



1 SPECIFICATIONS OF INTENDED USE

Anchorage subject to:

-Static and quasi-static loads

Base materials:

-Reinforced or unreinforced non-cracked normal weight concrete strength classes C20/25 to C50/60 according to EN 206-1:2000 (see ETA 13/0032)
-Dry or wet masonry (see ETA13/0033, Annex B1)

Approvals:

-European Technical Assessment in accordance with ETAG 029
-European Technical Assessment Option 7 for use in non-cracked concrete

Reaction to fire:

-Anchorage satisfy requirements for Class A1

Resistance to fire:

-No performance assessed

Installation:

-Dry or wet structures
-Anchor Installation carried out by appropriately qualified personnel and under the supervision of the person responsible for technical matters of the site

2 PLASTIC SLEEVE

Sleeve MIT-SH-K2				
Product name	Outer diameter	Length	Effective anchorage depth	Article code
	d_s [mm]	l_s [mm]	$h_{ef} = h_{nom}$ [mm]	
SH 12x80	12	80	80	1710145
SH 16x85	16	85	85	1710146
SH 16x130	16	130	130	1710150
SH 16x130/330	16	330	130	1710154
SH 20x85	20	85	85	1710147
SH 20x130	20	130	130	1710148
SH 20x200	20	200	200	1710149

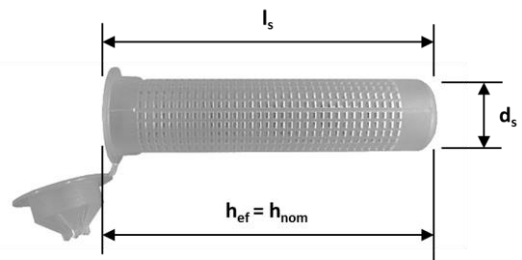

3 INSTALLATION AND CURING TIME

	MAXIMUM WORKING TIME AND MINIMUM CURING TIME							
	-5 ÷ -1°C	0 ÷ 4°C	5 ÷ 9°C	10 ÷ 14°C	15 ÷ 19°C	20 ÷ 29°C	30 ÷ 34°C	35 ÷ 39°C
max. working time t_{gel}	90 min	45 min	25 min	20 min	15 min	6 min	4 min	2 min
min. curing time t_{cure}	6 h	3 h	2 h	100 min	80 min	45 min	25 min	20 min

Graphic installation guide for MIT-SP Injection system

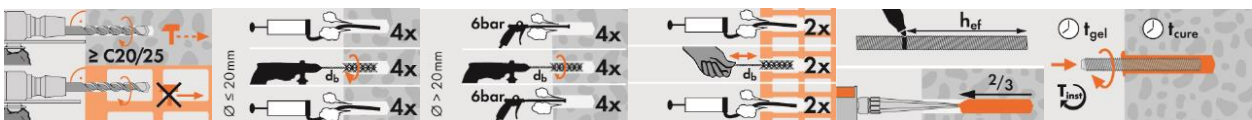

Installation: Steel brush



Installation parameters in Autoclaved Aerated Concrete and solid masonry (WITHOUT SLEEVE)

Threaded rod			M8	M10	M12	M16
Nominal drill hole diameter	d_0	[mm]	10	12	14	18
Drill hole depth	h_0	[mm]	80	90	100	100
Effective anchorage depth	$h_{ef} = h_{nom}$	[mm]	80	90	100	100
Minimum wall thickness	h_{min}	[mm]	hef + 30 mm			
Dieameter of clearance hole in the fixture	$d_f \leq$	[mm]	9	12	14	18
Diameter of Steel brush	d_b	[mm]	12	14	16	20
Steel bruch article code			1690040	1690041	1690042	1690044

Installation parameters in solid and hollow masonry (WITH SLEEVE)

Threaded rod			M8	M8/M10		M12/M16			
Sleeve			SH 12x80	SH 16x85	SH 16x130	SH 16x130/330	SH 20x85	SH 20x130	SH 20x200
Nominal drill hole diameter	d_0	[mm]	12	16	16	16	20	20	20
Drill hole depth	h_0	[mm]	85	90	135	$135 + t_{fix}^1$	90	135	205
Effective anchorage depth	$h_{ef} = h_{nom}$	[mm]	80	85	130	130	85	130	200
Minimum wall thickness	h_{min}	[mm]	115	115	175	175	115	175	240
Dieameter of clearance hole in the fixture	$d_f \leq$	[mm]	9	9 (M8) / 12 (M10)			14 (M12 / 18 (M16)		
Diameter of Steel brush	d_b	[mm]	14	18			22		
Steel bruch article code			1690041	1690043		1690045			

¹⁾ $t_{fix} < 200$ mm

4 RESISTANCE FOR THREADED RODS

Threaded rod size			M8	M10	M12	M16
Recommended tension resistance						
Steel, property class 4.6	$N_{rec,s}$	[kN]	5.36	8.21	12.14	22.50
Steel, property class 4.8	$N_{rec,s}$	[kN]	7.14	10.95	16.19	30.00
Steel, property class 5.6	$N_{rec,s}$	[kN]	6.43	10.36	15.00	28.21
Steel, property class 5.8	$N_{rec,s}$	[kN]	8.57	13.81	20.00	37.62
Steel, property class 8.8	$N_{rec,s}$	[kN]	13.81	21.90	31.90	60.00
Stainless steel A4 / HCR, property class 70	$N_{rec,s}$	[kN]	9.93	15.66	22.54	42.02
Stainless steel A4 / HCR, property class 80	$N_{rec,s}$	[kN]	12.95	20.54	29.91	56.25
Recommended shear resistance						
Steel, property class 4.6	$V_{rec,s}$	[kN]	2.99	5.13	7.27	13.26
Steel, property class 4.8	$V_{rec,s}$	[kN]	4.00	6.86	9.71	17.71
Steel, property class 5.6	$V_{rec,s}$	[kN]	3.85	6.42	8.98	16.68
Steel, property class 5.8	$V_{rec,s}$	[kN]	5.14	8.57	12.00	22.29
Steel, property class 8.8	$V_{rec,s}$	[kN]	8.57	13.14	19.43	36.00
Stainless steel A4 / HCR, property class 70	$V_{rec,s}$	[kN]	5.95	9.16	13.74	25.18
Stainless steel A4 / HCR, property class 80	$V_{rec,s}$	[kN]	8.06	12.35	18.26	33.83
Recommended bending moment resistance						
Steel, property class 4.6	$M_{rec,s}$	[Nm]	6.42	12.83	22.24	56.89
Steel, property class 4.8	$M_{rec,s}$	[Nm]	8.57	17.14	29.71	76.00
Steel, property class 5.6	$M_{rec,s}$	[Nm]	8.13	15.83	27.80	71.00
Steel, property class 5.8	$M_{rec,s}$	[Nm]	10.86	21.14	37.14	94.86
Steel, property class 8.8	$M_{rec,s}$	[Nm]	17.14	34.29	60.00	152.00
Stainless steel A4 / HCR, property class 70	$M_{rec,s}$	[Nm]	11.90	23.81	42.12	106.23
Stainless steel A4 / HCR, property class 80	$M_{rec,s}$	[Nm]	16.11	32.22	56.39	142.86

The partial safety factors of the resistance as well as a partial safety factor of the load of $\gamma_F = 1,4$ are considered

5. VALUES OF RESISTANCE UNDER TENSION AND SHEAR LOADS

Load capacity under tension and shear load according to ETA-13/0033 in dry and wet masonry.

Recommended loads are given for max. short term temperature +40°C/ max. long term temperature +24°C or max. short term temperature +80°C/ max. long term temperature +50°C. Recommended shear loads are suitable for both temperature ranges given for recommended tension.

5.1 Autoclaved aerated concrete units according EN 771-4

Autoclaved Aerated Concrete AAC6		Anchor size	Edge distance $C_{min}=C_{cr}$ [mm]	Spacing		Max. installation torque [Nm]
				$S_{cr}=S_{min}$ [mm]	$S_{min} \perp$ [mm]	
Bulk density [kg/dm ³]	0,60	M8	120	240	240	2
Code	EN 771-4	M10	135	270	270	
Brick dimensions [mm]	499 x 240 x 249	M12/M16	150	300	300	
Anchor size	Drill hole diameter d_0 [mm]	Eff. anchorage depth h_{ef} [mm]	Recommended tension load (N_{rec})		Recommended shear load (V_{rec}) For all temperature range	
			40°C / 24°C	80°C / 50°C [kN]		
Copressive strength $f_b \geq 6$ N/mm²						
INSTALLATION IN DRY MASONRY						
M8	10	80	0.71	0.71	1.96	
M10	12	90	1.07	0.89	3.21	
M12	14	100	1.61	1.25	3.21	
M16	18	100	1.96	1.61	3.93	
INSTALLATION IN WET MASONRY						
M8	10	80	0.71	0.71	1.96	
M10	12	90	0.89	0.71	3.21	
M12	14	100	1.07	0.89	3.21	
M16	18	100	1.25	1.07	3.93	

5.2 Calcium silicate masonry units according EN 771-2

Calcium silicate solid brick KS-NF		Anchor size	Edge distance $C_{min}=C_{cr}$ [mm]	Spacing		Max. installation torque [Nm]
				$S_{cr}=S_{min} \parallel$ [mm]	$S_{min} \perp$ [mm]	
Bulk density [kg/dm ³]	2,0	M8	120	240	240	10
Code	EN 771-2	M10	135	270	270	20
Brick dimensions [mm]	240 x 115 x 71	M12/M16	150	300	300	
Anchor size	Drill hole diameter d_0 [mm]	Eff. anchorage depth h_{ef} [mm]	Recommended tension load (N_{rec}) 40°C / 24°C	Recommended tension load (N_{rec}) 80°C / 50°C	Recommended shear load (V_{rec}) For all temperature range	
			[kN]			
Copressive strength $f_b \geq 10 \text{ N/mm}^2$						
M8	10	80	0.86	0.57	0.86	
M10	12	90	0.86	0.57	0.86	
M12	14	100	1.14	0.71	1.00	
M16	18	100	0.86	0.57	1.00	
Copressive strength $f_b \geq 20 \text{ N/mm}^2$						
M8	10	80	1.29	0.86	1.29	
M10	12	90	1.29	0.86	1.29	
M12	14	100	1.57	1.00	1.43	
M16	18	100	1.29	0.86	1.43	
Copressive strength $f_b \geq 27 \text{ N/mm}^2$						
M8	10	80	1.57	1.00	1.43	
M10	12	90	1.57	1.00	1.57	
M12	14	100	1.86	1.29	1.71	
M16	18	100	1.57	1.00	1.71	

Calcium silicate hollow brick KS L-3DF		Anchor size	Edge distance $C_{min}=C_{cr}$ [mm]	Spacing		Max. installation torque [Nm]
				$S_{cr}=S_{min} \parallel$ [mm]	$S_{min} \perp$ [mm]	
Bulk density [kg/dm ³]	1,4	M8/M10	100	240	113	8
Code	EN 771-2					
Brick dimensions [mm]	240 x 175 x 113	M12/M16	120			
Anchor size	Sleeve	Eff. anchorage depth h_{ef} [mm]	Recommended tension load (N_{rec}) 40°C / 24°C	Recommended tension load (N_{rec}) 80°C / 50°C	Recommended shear load (V_{rec}) For all temperature range	
			[kN]			
Copressive strength $f_b \geq 8 \text{ N/mm}^2$						
M8	SH 12x80	80	0.43	0.26	0.57	
M8/M10	SH 16x85	85	0.43	0.26	0.71	
M8/M10	SH 16x130 / SH 16x130/330	130	0.71	0.43	0.86	
M12/M16	SH 20x85	85	0.43	0.26	0.86	
M12	SH 20x130 / SH20x200	130/200	0.71	0.43	0.86	
M16	SH 20x130 / SH20x200	130/200	0.71	0.43	1.14	
Copressive strength $f_b \geq 12 \text{ N/mm}^2$						
M8	SH 12x80	80	0.57	0.34	0.71	
M8/M10	SH 16x85	85	0.57	0.34	1.00	
M8/M10	SH 16x130 / SH 16x130/330	130	1.00	0.57	1.29	
M12/M16	SH 20x85	85	0.57	0.34	1.00	
M12	SH 20x130 / SH20x200	130/200	1.00	0.57	1.29	
M16	SH 20x130 / SH20x200	130/200	1.00	0.57	1.43	
Copressive strength $f_b \geq 14 \text{ N/mm}^2$						
M8	SH 12x80	80	0.71	0.43	0.86	
M8/M10	SH 16x85	85	0.71	0.43	1.14	
M8/M10	SH 16x130 / SH 16x130/330	130	1.14	0.86	1.43	
M12/M16	SH 20x85	85	0.71	0.43	1.29	
M12	SH 20x130 / SH20x200	130/200	1.14	0.86	1.43	
M16	SH 20x130 / SH20x200	130/200	1.14	0.86	1.71	

Calcium silicate hollow brick KS L-12DF		Anchor size	Edge distance	Spacing		Max. installation torque [Nm]	
				$C_{min}=C_{cr}$	$S_{cr}=S_{min} \parallel$		$S_{min} \perp$
				[mm]	[mm]		[mm]
Bulk density [kg/dm ³]	1,4	M8 - SH 12x80	100	498	238	2	
Code	EN 771-2	M8/M10	100			4	
Brick dimensions [mm]	498 x 175 x 238	M12/M16	120				

Anchor size	Sleeve	Eff. anchorage depth h_{ef} [mm]	Recommended tension load (N_{rec})	Recommended tension load (N_{rec})	Recommended shear load (V_{rec})
			40°C / 24°C	80°C / 50°C	For all temperature range
			[kN]		
Copressive strength $f_b \geq 10$ N/mm²					
M8	SH 12x80	80	0.11	0.09	0.86
M8/M10	SH 16x85	85	0.34	0.26	1.71
M8/M10	SH 16x130 / SH 16x130/330	130	1.00	0.71	2.00
M12/M16	SH 20x85	85	0.34	0.26	1.71
M12/M16	SH 20x130 / SH20x200	130/200	1.00	0.71	2.00
Copressive strength $f_b \geq 12$ N/mm²					
M8	SH 12x80	80	0.11	0.09	1.00
M8/M10	SH 16x85	85	0.43	0.26	2.00
M8/M10	SH 16x130 / SH 16x130/330	130	1.29	0.86	2.29
M12/M16	SH 20x85	85	0.43	0.26	2.00
M12/M16	SH 20x130 / SH20x200	130/200	1.29	0.86	2.29
Copressive strength $f_b \geq 16$ N/mm²					
M8	SH 12x80	80	0.14	0.11	1.14
M8/M10	SH 16x85	85	0.57	0.34	2.57
M8/M10	SH 16x130 / SH 16x130/330	130	1.57	1.00	2.86
M12/M16	SH 20x85	85	0.57	0.34	2.43
M12/M16	SH 20x130 / SH20x200	130/200	1.57	1.00	2.86

5.3 Clay masonry units according EN 771-1

Clay solid brick Mz-DF		Anchor size	Edge distance	Spacing		Max. installation torque [Nm]	
				$C_{min}=C_{cr}$	$S_{cr}=S_{min} \parallel$		$S_{min} \perp$
				[mm]	[mm]		[mm]
Bulk density [kg/dm ³]	1,64	M8	120	240	240	6	
Code	EN 771-1	M10	135	270	270	10	
Brick dimensions [mm]	240 x 115 x 55	M12/M16	150	300	300		

Anchor size	Drill hole diameter d_0 [mm]	Eff. anchorage depth h_{ef} [mm]	Recommended tension load (N_{rec})	Recommended tension load (N_{rec})	Recommended shear load (V_{rec})
			40°C / 24°C	80°C / 50°C	For all temperature range
			[kN]		
Copressive strength $f_b \geq 10$ N/mm²					
M8	10	80	0.43	0.34	0.86
M10	12	90	0.43	0.34	1.00
M12	14	100	0.43	0.26	1.43
M16	18	100	0.71	0.43	1.43
Copressive strength $f_b \geq 20$ N/mm²					
M8	10	80	0.71	0.43	1.29
M10	12	90	0.71	0.43	1.57
M12	14	100	0.57	0.43	2.14
M16	18	100	1.00	0.71	2.14
Copressive strength $f_b \geq 28$ N/mm²					
M8	10	80	0.86	0.57	1.57
M10	12	90	0.86	0.57	1.86
M12	14	100	0.71	0.43	2.57
M16	18	100	1.29	0.86	2.57

Clay hollow brick Porotherm Homebrick		Anchor size	Edge distance	Spacing		Max. installation torque [Nm]
				$C_{min}=C_{cr}$ [mm]	$S_{cr}=S_{min}$ [mm]	
Bulk density [kg/dm ³]	0,68	M8 - SH 12x80	100	500	299	2
Code	EN 771-1	M8/M10	100			6
Brick dimensions [mm]	500 x 200 x 299	M12/M16	120			
Anchor size	Sleeve	Eff. anchorage depth h_{ef} [mm]	Recommended tension load (N_{rec})	Recommended tension load (N_{rec})	Recommended shear load (V_{rec})	
			40°C / 24°C	80°C / 50°C	For all temperature range	
[kN]						
Coppressive strength $f_b \geq 6$ N/mm ²						
M8	SH 12x80	80	0.26	0.21	0.57	
M8/M10	SH 16x85	85	0.34	0.21	0.57	
M8/M10	SH 16x130 / SH 16x130/330	130	0.43	0.26	0.71	
M12/M16	SH 20x85	85	0.34	0.21	0.86	
M12/M16	SH 20x130	130	0.43	0.26	0.86	
Coppressive strength $f_b \geq 8$ N/mm ²						
M8	SH 12x80	80	0.34	0.26	0.71	
M8/M10	SH 16x85	85	0.34	0.26	0.71	
M8/M10	SH 16x130 / SH 16x130/330	130	0.43	0.34	0.86	
M12/M16	SH 20x85	85	0.34	0.26	1.00	
M12/M16	SH 20x130	130	0.43	0.34	1.00	
Coppressive strength $f_b \geq 10$ N/mm ²						
M8	SH 12x80	80	0.34	0.26	0.86	
M8/M10	SH 16x85	85	0.43	0.26	0.86	
M8/M10	SH 16x130 / SH 16x130/330	130	0.57	0.34	1.00	
M12/M16	SH 20x85	85	0.43	0.26	1.14	
M12/M16	SH 20x130	130	0.57	0.34	1.14	

Clay hollow brick Blocchi Leggeri		Anchor size	Edge distance	Spacing		Max. installation torque [Nm]
				$C_{min}=C_{cr}$ [mm]	$S_{cr}=S_{min}$ [mm]	
Bulk density [kg/dm ³]	0,55	M8/M10	100	250	250	4
Code	EN 771-1		100			
Brick dimensions [mm]	250 x 120 x 250	M12/M16	120			
Anchor size	Sleeve	Eff. anchorage depth h_{ef} [mm]	Recommended tension load (N_{rec})	Recommended tension load (N_{rec})	Recommended shear load (V_{rec})	
			40°C / 24°C	80°C / 50°C	For all temperature range	
[kN]						
Coppressive strength $f_b \geq 4$ N/mm ²						
M8	SH 12x80	80	0.11	0.09	0.57	
M10	SH 16x85	85	0.11	0.09	0.57	
M8/M10	SH 16x130 / SH 16x130/330	130	0.14	0.09	0.57	
M12/M16	SH 20x85	85	0.11	0.09	0.57	
M12/M16	SH 20x130 / SH 20x200	130/200	0.14	0.09	0.57	
Coppressive strength $f_b \geq 6$ N/mm ²						
M8	SH 12x80	80	0.14	0.09	0.57	
M10	SH 16x85	85	0.14	0.09	0.57	
M8/M10	SH 16x130 / SH 16x130/330	130	0.17	0.11	0.57	
M12/M16	SH 20x85	85	0.14	0.09	0.71	
M12/M16	SH 20x130 / SH 20x200	130/200	0.17	0.11	0.71	
Coppressive strength $f_b \geq 8$ N/mm ²						
M8	SH 12x80	80	0.17	0.11	0.71	
M10	SH 16x85	85	0.17	0.11	0.71	
M8/M10	SH 16x130 / SH 16x130/330	130	0.17	0.14	0.71	
M12/M16	SH 20x85	85	0.17	0.11	0.86	
M12/M16	SH 20x130 / SH 20x200	130/200	0.17	0.14	0.86	

Clay hollow brick HLZ-16DF		Anchor size	Edge distance	Spacing		Max. installation torque
				$C_{min}=C_{cr}$	$S_{cr}=S_{min}$	
Bulk density [kg/dm ³]	0,83		[mm]	[mm]	[mm]	[Nm]
Code	EN 771-1	M8/M10	100	497	238	6
Brick dimensions [mm]	497 x 240 x 238	M12/M16	120			
Anchor size	Sleeve	Eff. anchorage depth h_{ef} [mm]	Recommended tension load (N_{rec})		Recommended shear load (V_{rec})	
			40°C / 24°C	80°C / 50°C		
Copressive strength $f_b \geq 6$ N/mm²						
M8	SH 12x80	80	0.34	0.21	0.71	
M8	SH 16x130 / SH 16x130/330	130	0.71	0.43	1.14	
M8/M10	SH 16x85	85	0.43	0.34	1.14	
M10	SH 16x130 / SH 16x130/330	130	0.71	0.43	1.71	
M12/M16	SH 20x85	85	0.57	0.43	1.14	
M12/M16	SH 20x130 / SH20x200	130/200	0.71	0.43	1.71	
Copressive strength $f_b \geq 9$ N/mm²						
M8	SH 12x80	80	0.34	0.26	0.86	
M8	SH 16x130 / SH 16x130/330	130	0.86	0.57	1.43	
M8/M10	SH 16x85	85	0.57	0.43	1.29	
M10	SH 16x130 / SH 16x130/330	130	0.86	0.57	2.00	
M12/M16	SH 20x85	85	0.71	0.57	1.43	
M12/M16	SH 20x130 / SH20x200	130/200	0.86	0.57	2.00	
Copressive strength $f_b \geq 12$ N/mm²						
M8	SH 12x80	80	0.43	0.34	1.00	
M8	SH 16x130 / SH 16x130/330	130	1.00	0.71	1.71	
M8/M10	SH 16x85	85	0.71	0.43	1.57	
M10	SH 16x130 / SH 16x130/330	130	1.00	0.71	2.29	
M12/M16	SH 20x85	85	1.00	0.57	1.71	
M12/M16	SH 20x130 / SH20x200	130/200	1.00	0.71	2.29	
Copressive strength $f_b \geq 14$ N/mm²						
M8	SH 12x80	80	0.43	0.34	1.14	
M8	SH 16x130 / SH 16x130/330	130	1.00	0.71	1.86	
M8/M10	SH 16x85	85	0.71	0.57	1.71	
M10	SH 16x130 / SH 16x130/330	130	1.00	0.71	2.57	
M12/M16	SH 20x85	85	1.00	0.57	1.71	
M12/M16	SH 20x130 / SH20x200	130/200	1.00	0.71	2.57	

Clay hollow brick Urbanbrick		Anchor size	Edge distance	Spacing		Max. installation torque
				$C_{min}=C_{cr}$	$S_{cr}=S_{min}$	
Bulk density [kg/dm ³]	0,74		[mm]	[mm]	[mm]	[Nm]
Code	EN 771-1	M8/M10	100	560	274	2
Brick dimensions [mm]	560 x 200 x 274	M12/M16	120			
Anchor size	Sleeve	Eff. anchorage depth h_{ef} [mm]	Recommended tension load (N_{rec})		Recommended shear load (V_{rec})	
			40°C / 24°C	80°C / 50°C		
Copressive strength $f_b \geq 6$ N/mm²						
M8	SH 12x80	80	0.26	0.21	0.86	
M8/M10	SH 16x85	85	0.34	0.21	1.00	
M8/M10	SH 16x130 / SH 16x130/330	130	0.43	0.34	1.00	
M12/M16	SH 20x85	85	0.34	0.21	1.14	
M12/M16	SH 20x130 / SH20x200	130/200	0.43	0.34	1.14	
Copressive strength $f_b \geq 9$ N/mm²						
M8	SH 12x80	80	0.34	0.26	1.00	
M8/M10	SH 16x85	85	0.43	0.26	1.14	
M8/M10	SH 16x130 / SH 16x130/330	130	0.57	0.43	1.29	
M12/M16	SH 20x85	85	0.43	0.26	1.43	
M12/M16	SH 20x130 / SH20x200	130/200	0.57	0.43	1.43	

Clay hollow brick BGV Thermo		Anchor size	Edge distance	Spacing		Max. installation torque [Nm]
			$C_{min}=C_{cr}$	$S_{cr}=S_{min \parallel}$	$S_{min \perp}$	
			[mm]	[mm]	[mm]	
Bulk density [kg/dm ³]	0,62	M8 - SH 12x80	100	500	314	2
Code	EN 771-1	M8/M10	100			4
Brick dimensions [mm]	500 x 200 x 314	M12/M16	120			
Anchor size	Sleeve	Eff. anchorage depth h_{ef} [mm]	Recommended tension load (N_{rec})	Recommended tension load (N_{rec})	Recommended shear load (V_{rec})	
			40°C / 24°C	80°C / 50°C	For all temperature range	
			[kN]			
Compressive strength $f_b \geq 4 \text{ N/mm}^2$						
M8	SH 12x80	80	0.14	0.11	0.57	
M8	SH 16x130 / SH 16x130/330	130	0.26	0.21	0.71	
M8/M10	SH 16x85	85	0.21	0.14	0.57	
M10	SH 16x130 / SH 16x130/330	130	0.34	0.21	0.71	
M12	SH 20x85	85	0.21	0.14	0.57	
M12/M16	SH 20x130	130	0.34	0.21	0.71	
M16	SH 20x85	85	0.26	0.17	0.57	
Compressive strength $f_b \geq 6 \text{ N/mm}^2$						
M8	SH 12x80	80	0.17	0.14	0.57	
M8	SH 16x130 / SH 16x130/330	130	0.34	0.26	0.86	
M8/M10	SH 16x85	85	0.26	0.17	0.71	
M10	SH 16x130 / SH 16x130/330	130	0.43	0.26	0.86	
M12	SH 20x85	85	0.26	0.17	0.86	
M12/M16	SH 20x130	130	0.43	0.26	0.86	
M16	SH 20x85	85	0.34	0.21	0.86	
Compressive strength $f_b \geq 10 \text{ N/mm}^2$						
M8	SH 12x80	80	0.26	0.17	0.86	
M8	SH 16x130 / SH 16x130/330	130	0.43	0.34	1.14	
M8/M10	SH 16x85	85	0.34	0.26	1.00	
M10	SH 16x130 / SH 16x130/330	130	0.43	0.34	1.14	
M12	SH 20x85	85	0.34	0.21	1.00	
M12/M16	SH 20x130	130	0.43	0.34	1.14	
M16	SH 20x85	85	0.43	0.26	1.00	

Clay hollow brick Calibric Th		Anchor size	Edge distance	Spacing		Max. installation torque [Nm]
			$C_{min}=C_{cr}$ [mm]	$S_{cr}=S_{min}$ [mm]	S_{min} ⊥ [mm]	
Bulk density [kg/dm ³]	0,62					
Code	EN 771-1	M8/M10	100	500	314	2
Brick dimensions [mm]	500 x 200 x 314	M12/M16	120			
Anchor size	Sleeve	Eff. anchorage depth h_{ef} [mm]	Recommended tension load (N_{rec})		Recommended shear load (V_{rec}) For all temperature range	
			40°C / 24°C	80°C / 50°C		
Compressive strength $f_b \geq 6$ N/mm²						
M8	SH 12x80	80	0.21	0.14	0.71	
M8/M10	SH 16x85	85	0.21	0.14	1.00	
M8/M10	SH 16x130 / SH 16x130/330	130	0.26	0.17	1.00	
M12	SH 20x85	85	0.21	0.14	1.71	
M12	SH 20x130	130	0.26	0.17	1.71	
M16	SH 20x85 / SH 20x130	85 / 130	0.34	0.21	1.71	
Compressive strength $f_b \geq 8$ N/mm²						
M8	SH 12x80	80	0.26	0.17	1.00	
M8/M10	SH 16x85	85	0.26	0.17	1.29	
M8/M10	SH 16x130 / SH 16x130/330	130	0.34	0.21	1.29	
M12	SH 20x85	85	0.26	0.17	2.14	
M12	SH 20x130	130	0.34	0.26	2.14	
M16	SH 20x85 / SH 20x130	85 / 130	0.43	0.26	2.14	
Compressive strength $f_b \geq 10$ N/mm²						
M8	SH 12x80	80	0.26	0.21	1.14	
M8/M10	SH 16x85	85	0.26	0.21	1.57	
M8/M10	SH 16x130 / SH 16x130/330	130	0.34	0.26	1.57	
M12	SH 20x85	85	0.26	0.21	2.43	
M12	SH 20x130	130	0.43	0.26	2.43	
M16	SH 20x85 / SH 20x130	85 / 130	0.43	0.34	2.43	

Clay hollow brick Doppio Uni		Anchor size	Edge distance	Spacing		Max. installation torque
				$C_{min}=C_{cr}$	$S_{cr}=S_{min \parallel}$	
Bulk density [kg/dm ³]	0,92		[mm]	[mm]	[mm]	[Nm]
Code	EN 771-1	M8/M10	100	250	120	4
Brick dimensions [mm]	250 x 120 x 120	M12/M16	120			
Anchor size	Sleeve	Eff. anchorage depth h_{ef} [mm]	Recommended tension load (N_{rec})		Recommended shear load (V_{rec})	
			40°C / 24°C	80°C / 50°C		
[kN]						
Copressive strength $f_b \geq 10$ N/mm²						
M8	SH 12x80	80		0.26	0.17	0.57
M8/M10	SH 16x85	85		0.26	0.17	0.57
M8/M10	SH 16x130 / SH 16x130/330	130		0.26	0.17	0.57
M12/M16	SH 20x85	85		0.34	0.21	0.57
M12/M16	SH 20x130 / SH20x200	130/200		0.34	0.21	0.57
Copressive strength $f_b \geq 16$ N/mm²						
M8	SH 12x80	80		0.26	0.21	0.71
M8/M10	SH 16x85	85		0.34	0.26	0.71
M8/M10	SH 16x130 / SH 16x130/330	130		0.34	0.26	0.71
M12/M16	SH 20x85	85		0.43	0.26	0.71
M12/M16	SH 20x130 / SH20x200	130/200		0.43	0.26	0.71
Copressive strength $f_b \geq 20$ N/mm²						
M8	SH 12x80	80		0.34	0.21	0.86
M8/M10	SH 16x85	85		0.34	0.26	0.86
M8/M10	SH 16x130 / SH 16x130/330	130		0.43	0.26	0.86
M12/M16	SH 20x85	85		0.43	0.26	0.86
M12/M16	SH 20x130 / SH20x200	130/200		0.43	0.26	0.86
Copressive strength $f_b \geq 28$ N/mm²						
M8	SH 12x80	80		0.43	0.26	1.00
M8/M10	SH 16x85	85		0.43	0.34	1.00
M8/M10	SH 16x130 / SH 16x130/330	130		0.43	0.34	1.00
M12/M16	SH 20x85	85		0.57	0.34	1.00
M12/M16	SH 20x130 / SH20x200	130/200		0.57	0.34	1.00

5.4 Light weight concrete according EN 771-3

Hollow Light weight concrete Bloc creux B40		Anchor size	Edge distance	Spacing		Max. installation torque
				$C_{min}=C_{cr}$	$S_{cr}=S_{min \parallel}$	
Bulk density [kg/dm ³]	0,8		[mm]	[mm]	[mm]	[Nm]
Code	EN 771-3	M8/M10	100	494	190	2
Brick dimensions [mm]	494 x 200 x 190	M12/M16	120			
Anchor size	Sleeve	Eff. anchorage depth h_{ef} [mm]	Recommended tension load (N_{rec})		Recommended shear load (V_{rec})	
			40°C / 24°C	80°C / 50°C		
[kN]						
Copressive strength $f_b \geq 4$ N/mm²						
M8	SH 12x80	80		0.11	0.09	0.34
M8/M10	SH 16x85	85		0.17	0.14	0.86
M8/M10	SH 16x130 / SH 16x130/330	130		0.57	0.43	1.00
M12/M16	SH 20x85	85		0.26	0.17	0.86
M12/M16	SH 20x130	130		0.57	0.43	1.00

Solid light weight concrete brick		Anchor size	Edge distance $C_{min}=C_{cr}$ [mm]	Spacing		Max. installation torque [Nm]
				$S_{cr}=S_{min}$	$S_{min} \perp$	
				[mm]	[mm]	
Bulk density [kg/dm ³]	0,63	M8	120	240	240	6
Code	EN 771-3	M10	135	270	270	
Brick dimensions [mm]	300 x 123 x 248	M12	150	300	300	
		M16	150	300	300	
Anchor size	Drill hole diameter d_0 [mm]	Eff. anchorage depth h_{ef} [mm]	Recommended tension load (N_{rec})		Recommended shear load (V_{rec})	
			40°C / 24°C	80°C / 50°C	For all temperature range	
			[kN]			
Compressive strength $f_b \geq 2$ N/mm ²						
M8	10	80	0.57	0.43	0.86	
M10	12	90	0.57	0.43	1.00	
M12	14	100	0.57	0.43	1.14	
M16	18	100	0.57	0.43	1.14	

Hollow light weight concrete brick - Leca Lex harkko RUH-200		Anchor size	Edge distance $C_{min}=C_{cr}$ [mm]	Spacing		Max. installation torque [Nm]
				$S_{cr}=S_{min}$	$S_{min} \perp$	
				[mm]	[mm]	
Bulk density [kg/dm ³]	0,7	SH 12x80	120	498	195	8
Code	EN 771-3	SH 16x85	127			
Brick dimensions [mm]	494 x 200 x 195	SH 16x130	195			
		SH 16x130/330	195			
		SH 20x85	127			
		SH 20x130	195			
Anchor size	Sleeve	Eff. anchorage depth h_{ef} [mm]	Recommended tension load (N_{rec})		Recommended shear load (V_{rec})	
			40°C / 24°C	80°C / 50°C	For all temperature range	
			[kN]			
Compressive strength $f_b \geq 2,7$ N/mm ²						
M8	SH 12x80	80	0.57	0.34	0.71	
M8/M10	SH 16x85	85	0.57	0.34	1.00	
M8/M10	SH 16x130 / SH 16x130/330	130	0.71	0.43	1.00	
M12/M16	SH 20x85	85	0.71	0.43	1.00	
M12/M16	SH 20x130	130	0.71	0.43	1.00	

Solid light weight concrete brick - Leca Lex harkko RUH-200 kulma		Anchor size	Edge distance $C_{min}=C_{cr}$ [mm]	Spacing		Max. installation torque [Nm]
				$S_{cr}=S_{min}$	$S_{min} \perp$	
				[mm]	[mm]	
Bulk density [kg/dm ³]	0,78	M8	120	240	240	6
Code	EN 771-3	M10	135	270	270	12
Brick dimensions [mm]	494 x 200 x 195	M12	150	300	300	14
		M16	150	300	300	16
Anchor size	Drill hole diameter d_0 [mm]	Eff. anchorage depth h_{ef} [mm]	Recommended tension load (N_{rec})		Recommended shear load (V_{rec})	
			40°C / 24°C	80°C / 50°C	For all temperature range	
			[kN]			
Compressive strength $f_b \geq 3$ N/mm ²						
M8	10	80	0.57	0.34	0.86	
M10	12	90	0.86	0.57	1.14	
M12	14	100	0.86	0.57	1.14	
M16	18	100	0.86	0.57	1.14	

6 SPACING AND EDGE DISTANCES

Spacing and edge distances according to European Technical Assessment ETA 13/0033, Page 20

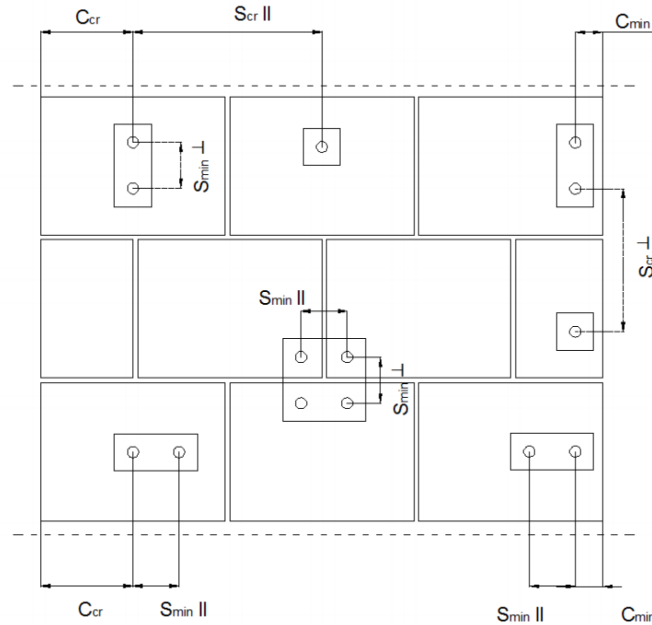

- C_{cr} = Characteristic edge distance
- $S_{cr II}$ = Characteristic spacing parallel to the bed joint
- $S_{cr \perp}$ = Characteristic spacing perpendicular to the bed joint
- C_{min} = Minimum edge distance
- $S_{min II}$ = Minimum spacing parallel to the bed joint
- $S_{min \perp}$ = Minimum spacing perpendicular to the bed joint

7 IMPORTANT NOTICE

For the design, the approval ETA 13/0033 should be considered.

1. Values given for solid brick types (AAC6, KS-NF, Mz-DF and RUH-200 Kulma) are been considered without plastic sleeve.
2. Given recommended loads are valued in dry and wet masonry.
3. The partial safety factors of the resistances as well as a partial safety factor $\gamma_F = 1,4$ are considered.
4. For minimum edge and pacing distances, given recommended loads needs to be reduced. For further details see the approval ETA 13/0033.
5. For combination of tensile- share loads and bending moments and also reduced edge and distances betw. anchors (anchor groups), see approval ETA 13/0033. Given loads only apply if the joints of the masonry are visible
6. The maximum anchoring depth results from the relevant anchor sleeve (Sleeve MIT-SH-K2). See "2 Plastic sleeve".
7. Resistance for tension, shear and bending moment for threaded rods see "4 Resistance for threaded rods" or approval ETA 13/0033.
8. The given specified types of brick in combination with the recommended loads given in this document are only an excerpt from the European Technical Approval ETA 13/0033.
9. For stone hole geometry see approval (ETA 13/0033).